



PowerBrick+

12v Lithium-Ion battery pack



12V battery pack - Lithium Iron-Phosphate (LiFePO₄) - 45Ah

- **High Service Life : 3000 cycles** and more (see chart)
- **Deep discharge** allowed up to 100 %
- Ultra safe **Lithium Iron Phosphate** chemistry (no thermal run-away, no fire or explosion risks)
- **Embedded BMS** (Battery Management System) : **improve lifespan AND secure the battery**
- No **Lead**, no **rare earths**, no **acid**, no **degassing**
- Calendar life > **10 years**
- Excellent **temperature** robustness (-20 °C up to +60 °C)
- **Flexible** deployment : up to 10 packs in parallel and 4 in serial
- **Constant power** during discharge (very low internal resistance)
- **Very low Peukert's losses** (energy efficiency >98 %)
- **Very low self discharge** (<3 % per month)
- **No memory effect**
- About **50 % lighter** and **40% smaller** than equivalent Lead-AGM battery with same usable energy
- **Certification : CE, RoHS**

Technical Specifications

Electric	Nominal voltage	12.8V
	Nominal capacity	45 Ah
	Stored energy	576 Wh
	Internal resistance	≤ 50mΩ
	Cycles	>3000 cycles (see chart)
	Self discharge	< 3% per month
	Energy efficiency	> 98%
Standard Charge	Charge voltage	14.4V ± 0.2V
	Charge mode	CC/CV : Constant Current / Constant Voltage
	Continuous charge current / Maximum charge current	25 A / 45 A
	BMS charge cut-off voltage	14.8V ± 0.1V
Standard Discharge	Continuous discharge current	55 A (704 W)
	Maximum discharge current (< 30s)	90 A (1.152 kW)
	BMS discharge cut-off voltage	10 V
Environment	Charge temperature range	0°C to +50°C
	Discharge temperature range	-20°C to +60°C
	Storage temperature	0°C to +50°C @60±25% relative humidity
	IP protection level	IP 66
Mechanical	Cell assembly	26650 - 4S12P
	Casing material	ABS
	Dimensions	L : 196mm x P : 135mm x H : 172 mm
	Weight	5.36 kg
	Terminal	M6



APPLICATIONS

- **Electrical vehicles and utilities**
- **Solar and wind energy storage**
- **Marine**
- **Street lightning**
- **CCTV and security camera**
- **UPS, electric back-up**
- **Telecom**
- **Medical equipments**
- ...



PowerBrick+

12v Lithium-Ion battery pack



Charts and curves

Different Rate Discharge Curve @25°C

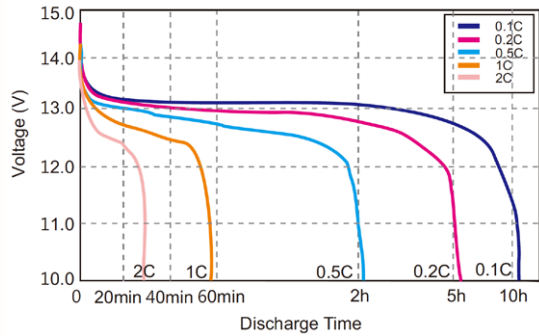

Different Temperature Discharge Curve @0.5C

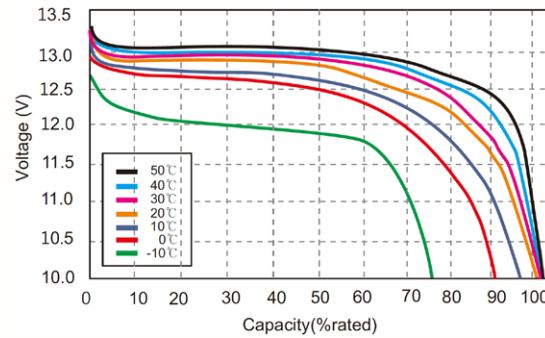

State of Charge Curve @0.5C 25°C

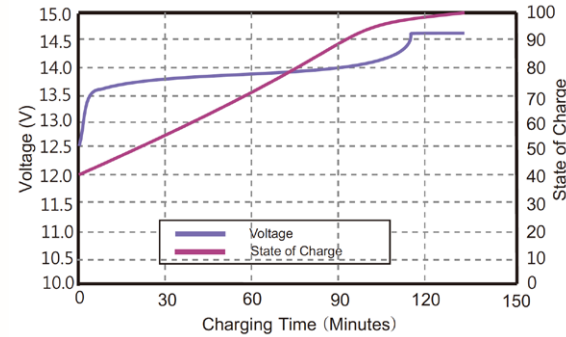

Charging Characteristics @0.5C 25°C

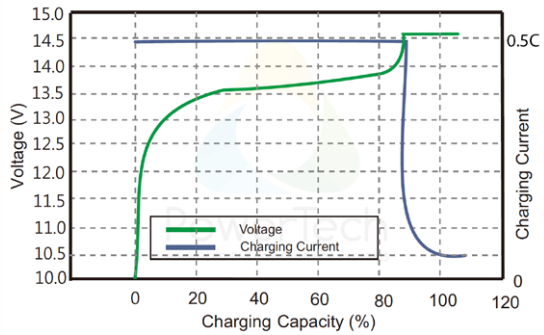

Number of cycles vs. Depth of discharge (DoD)

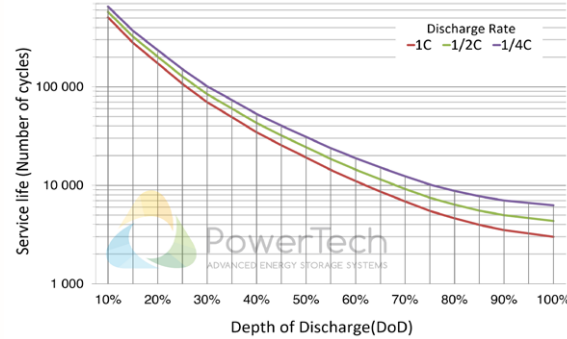

Different Temperature Self Discharge Curve

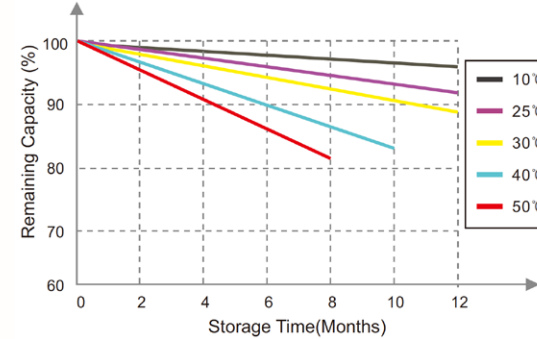

Dimensions

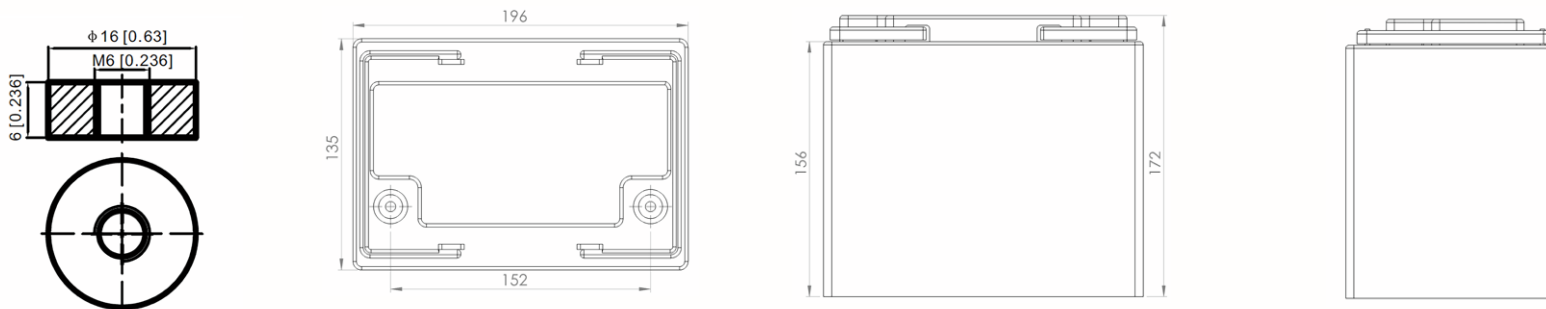

V1.1

PowerTech Systems SAS
Technoparc - Espace Cristal
22 Rue Gustave Eiffel
78300 POISSY - France

SAS au capital de 400 000 Euros
SIREN : 793926577 - TVA : FR33793926577

www.powertechsystems.eu
+33 185 400 970
contact@powertechsystems.eu